

FRANKLIN Mobile Hotspot R526 QSG



Table of Contents

- Care and Maintenance----- 2
- Part 1. Getting to know the R526**
- 1.1 Package Contents ----- 3
- 1.2 Hardware Features of the R526----- 3
- Part 2. Setting up the R526**
- 2.1 Charging the battery----- 3
- 2.2 Battery Tips ----- 4
- 2.3 Using a LAN cable-----5
- Part 3. Using the R526**
- 3.1 Connecting the R526-----5.
- 3.2 Opening the Browser Interface ----- 6
- 3.3 Device Activation (Windows)----- 6
- 3.4 Device Activation (Mac users only)----- 7
- Part 4. Technical Specifications, Regulatory and Safety Information, Warranty, Trademarks & Copyright**
- 8
- 4.1 LED Overview ----- 8
- 4.2 Technical Specification----- 9
- 4.3 Safe Information ----- 9
- 4.4. Warranty ----- 9
- 4.5. Trademarks ----- 10

Thank you for choosing the Franklin R526.

Note.

- This manual briefly explains the preparation, installation process and safety precautions for using R526 router.
- We recommend you read this manual before using the R526.

Care and Maintenance

It is normal for your wireless device to get warm when you use it.

- Use your wireless device and accessories with care in clean environment.
- Keep the wireless device away from open flame or dusty environments.
- Protect your device and accessories from water and vapor and keep them dry.
- Do not drop, throw or bend your device.
- Clean your device with a piece of damp and soft antistatic cloth.
- Do not use any chemical agents (such as alcohol and benzene), chemical detergents or powder to clean the device.
- Do not leave your device or accessories in significantly high or low temperature environments.
- Use only manufacturer approved accessories and parts.
- Contact an authorized service center in regard to device or accessories abnormality.
- Do not dismantle or tamper with the device or accessories. Dismantling or tampering will these items will void the product’s warranty.

Part 1. Getting to know the R526

1.1 Package Contents

- Franklin R526 Mobile Hotspot
- QSG (Quick Start Guide)
- USB Power Adapter
- Carrying Pouch
- Li-ion 1,350mAh battery
- RJ45 port cover

1.2 Hardware Features of the R526

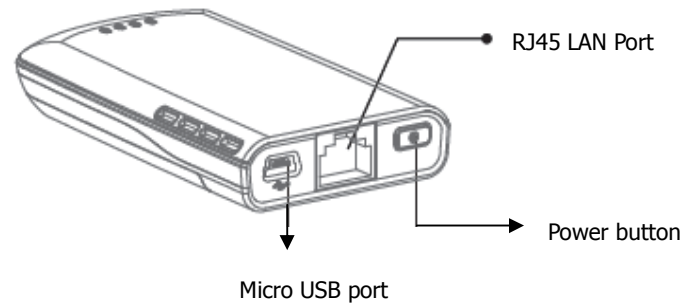

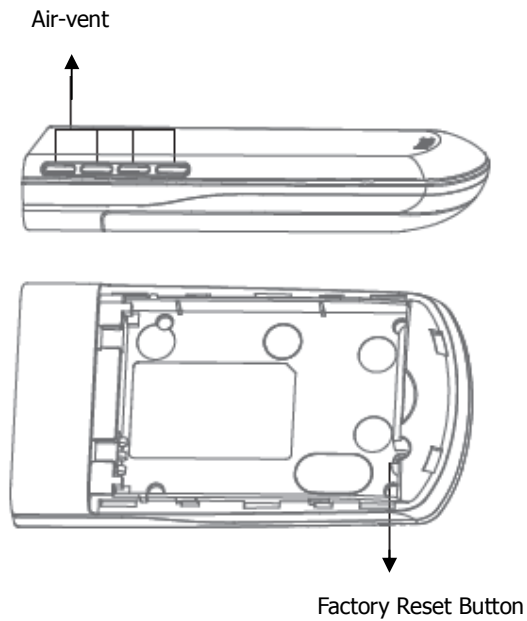

Part 2. Setting up the R526

2.1 Charging the battery

1. The battery compartment is located on the bottom of the device.

Slide open the battery compartment door by firmly pressing in the direction of the arrows.

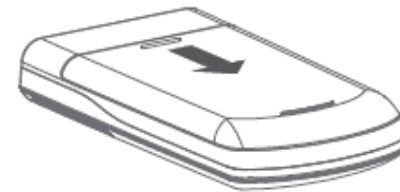

2. Insert the battery by lining up the gold contact points on the battery with the gold contact points in the battery compartment. Then press down gently until the battery is seated.

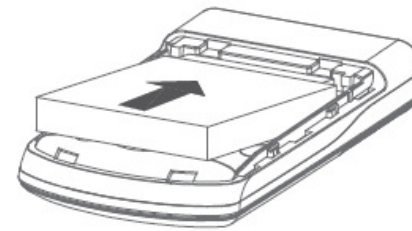

3. Replace the battery cover and slide it closed while pressing gently until it locks into place.

4. Connect the micro USB end of the USB Power Adapter to the micro USB port of the device.

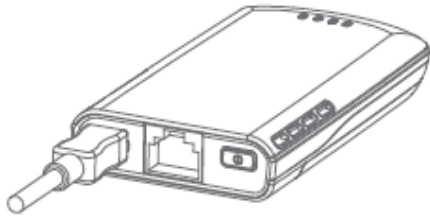

Note

- You must have a fully charged battery the first time you use the R526.
- After the first use, you may use the device while it is connected to the AC adapter.
- When using battery power, the device lasts up to 3 hours (when connected to a single device only).
- The battery will discharge more rapidly as additional devices access the R526.

2.2 Battery Tips

Warning

Use only Franklin Wireless approved batteries and chargers with your device.

Failure to use a Franklin Wireless approved battery and charger may increase the risk that your device will overheat, catch fire, and/or explode resulting in property damage, serious bodily injury, and/or death.

Battery life can vary based on the network, signal strength, temperature, features, and accessories you use.

- If you connect your device to your computer using a USB data cable, the battery will charge.
- It normally takes at least 3 hours to fully charge the battery with an A/C adapter.
- New batteries or batteries stored for a long time may take more time to charge.
- When charging your battery, keep it near room temperature.
- Never expose batteries to temperatures below 32°F (0°C) or above 113°F (45°C).

Never leave the device in an unattended vehicle due to uncontrollable temperatures that may be outside the recommended temperature range for this device.

It is normal for batteries to gradually weaken and require longer charging times. If you notice a change in your battery life, it is probably time to purchase a new battery.

2.3 Using a LAN cable (RJ45)

If you want to connect to RJ45 LAN cable to the R526, plug the cable to the RJ45 slot located between Micro USB port and power button.

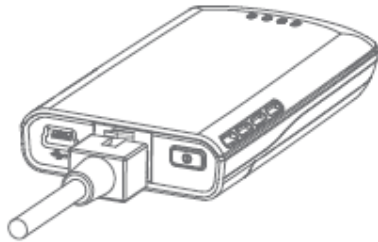

Part 3. Using the R526

3.1 Connecting the R526

When you press the power button:

- The R526 power LED should light up.
- A solid green power LED indicates if the device is charged over 40%.

1. Turn on the R526 ensure your WiFi is enabled on your PC or laptop. You can view your available wireless networks by going through the control panel, network connections or system tray (lower right hand corner of your screen).
2. Select “FRANKLIN_R526A XXXX” as your wireless network and enter the default network key, “12345”.

Note.

The last 4 digits, ‘XXXX’ of the SSID is the last four digits of your MAC address. You can find the MAC address of your R526 on the label under the battery.

3. Click *Connect*

3.2 Opening the Browser Interface

1. Open your web browser and enter *http://192.168.5.1/* into the address window.
2. Click *Login* button on the right top of the browser. The below pop up message will open to require administrative ID & Password. The default ID and Password is admin/admin.

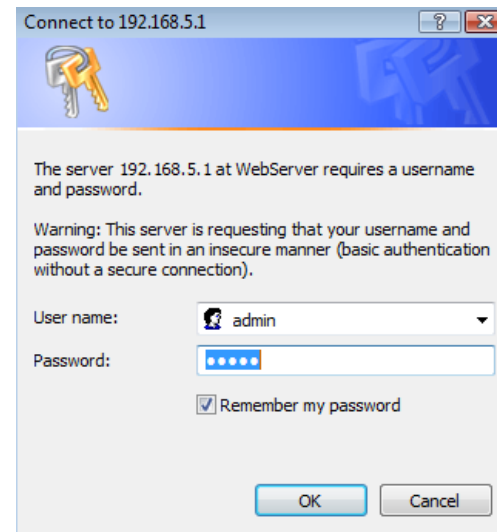

Type the administrative ID and password into the Login box and click ok.

3. The Browser Interface screen will open.

3.3 Device Activation (Windows)

If your device has not been activated at time of purchase, you must activate now.

Before you activate, you need SPC, MDN and MIN from the Carrier providing the service.

Click *OK*. Then, you will see the pop up screen requiring Manual Activation.

Activation process consists of 2 steps.

➤ 1st step is to input SPC. Input six '000000' for SPC (the SPC can be unique to the Carrier, confirm with your own Carrier before attempting to activate) and click *Apply*.

Manual Activation - Step 1 of 2	
Activation Code (SPC)	<input type="text"/>

If the Activation Code is incorrect, you will be asked to try again. If the Activation Code is correct, proceed to the 2nd step.

Activation Failed. Please try again.
<input type="button" value="Retry"/>

➤ 2nd step is to input MDN and MIN.

Manual Activation - Step 2 of 2	
MEID	A10000040002F1
MDN	<input type="text"/>
MIN	<input type="text"/>

Input the 10 digit MDN (Mobile Directory Number) and MIN (Mobile Identification Number) then click *Apply*. The MDN and MIN are provided by your carrier. Please contact your carrier for the correct MDN and MIN.

Activation Successful!!!
<input type="button" value="Home"/>

Web browser of the R526 will open.

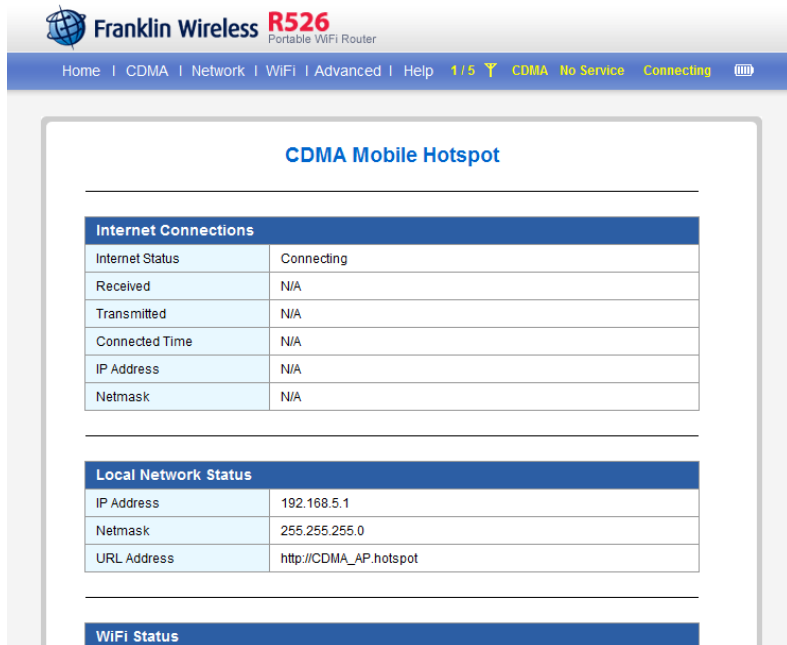

Click the Connect button to connect the internet.

3.4 Device Activation (Mac users only)

1. Go to Airport Icon at the right upper corner of desktop tap menu and click it,



And make it turn on to search the Wi-Fi networks around your place.

Put the cursor on Airport Icon and turn the Airport on as below.

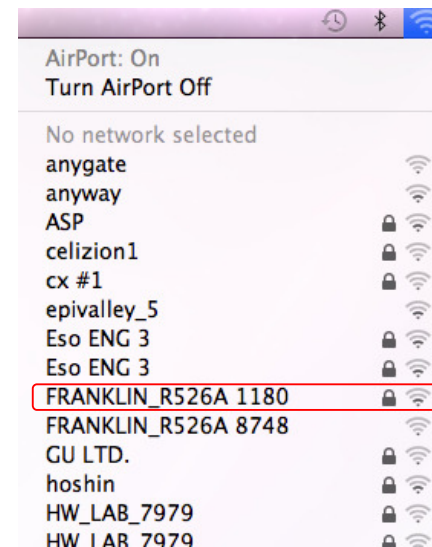

2. Choose "Open Network Preferences" on the drop-down menu and select "FRANKLIN_R526A XXXX" of your Wi-Fi network and enter the default network key, "12345".

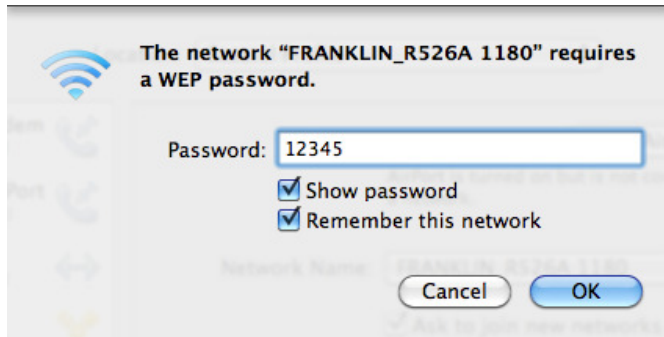
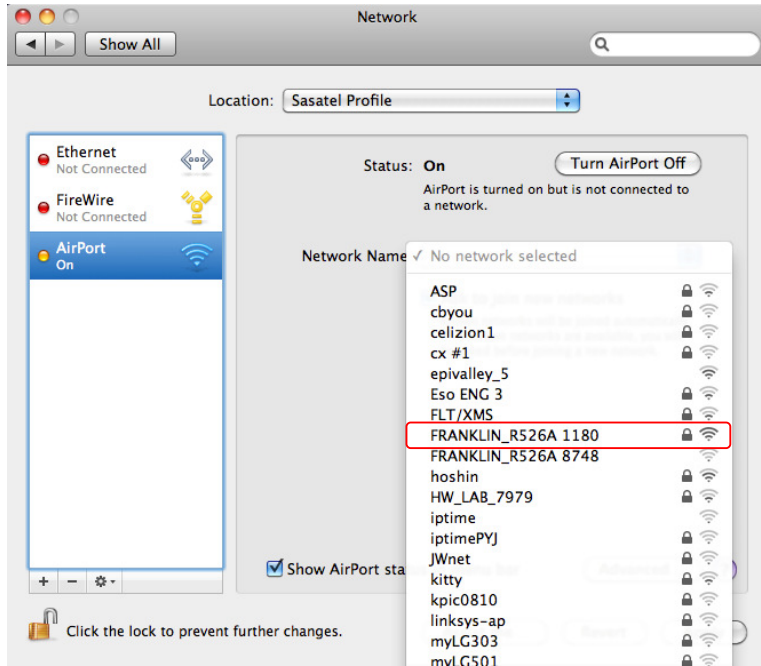

3. For device activation, please follow the steps in section “3.3 Device Activation.”

Part 4. Technical Specifications, Regulatory and Safety Information, Warranty, Trademarks & Copyright

4.1 LED Overview

Your device has Power/Wi-Fi/LAN/CDMA LEDs which provide status information about the device and network.

	LED Color		Indicates	
1	Power - Power on	No Light	No power	
		Red	Blinking	Battery level under 5%
			Solid	Battery level under 20%
		Orange	Solid	Battery level under 40% or In charging
	Green	Solid	Battery level over 40%	
	Power - Power off	Orange	Solid	In charging
		Green	Solid	Fully charged
				No battery but connected to AC

				adapter
2	Wi-Fi	No Light		Radio Off
		Blue	Solid	Radio on
3	LAN	No Light		Not connected
		Blue	Solid	Connected
4.	CDMA	Red	Solid	Not connected
		Green	Blinking	Activity
			Solid	Connected

4.2 Technical Specification

Size (W,D,H)	90mm x 50mm x 15mm (3.54 x 1.97 x 0.59 inch)
Weight	About 70g (2.47 oz)
Memory	Flash : 4MB / SDRAM : 16MB
RF Band	CDMA 800/1900MHz Dual Band Support
Data Rate	CDMA : 3.1Mbps downlink / 1.8Mbps uplink Wi-Fi : 54Mbps
Operating temperature	0°C to 45°C
Humidity	5 ~ 95%
Storage Temperature	-25°C to 45°C

Operating time	Running time : 3Hrs (When fully charged)
	Standby time : 6.5Hrs
LED indicators	Power / Wi-Fi / LAN / CDMA
Battery and charging	Li-ion 1,350mAh, 3.7V, Rechargeable
Power	AC Power Adapter 5V/2A

4.3 Safety Information

Body Worn Operation

Important safety information regarding radiofrequency radiation (RF) exposure.

To ensure compliance with RF exposure guidelines the device must be used with a minimum of 20cm separation from the body.

Failure to observe these instructions could result in your RF exposure exceeding the relevant guideline limits.

Regulatory Information (FCC Statement)

FCC Equipment Authorization ID: R2NSER-8189

This device complies with Part 15 of the FCC Rules. Operation is subject to the following two conditions: (1) this device may not cause harmful interference, and (2) this device must accept any interference received, including interference that may cause undesired operation.

* This device should be installed and operated with a minimum distance of 20 cm

between the radiator and your body when using it via USB cable.

4.4 Warranty

Manufacturer's Limited One-Year Warranty:

Franklin Wireless (the company) warrants to the original retail purchaser of this device, that should the product or any part thereof, during normal consumer usage conditions, be defective in material or workmanship that results in product failure within the first twelve (12) month period from the date of purchase, such defects will be repaired or replaced, with a new or refurbished product at the Company's discretion, without charge for parts and labor directly related to the defect(s). This warranty extends to consumers who purchase the product in the United States, Mexico, or Canada and it's not transferable or assignable. This warranty does not apply to:

- (a) Product subject to abnormal use or conditions, accident, mishandling, neglect, unauthorized alteration, misuse, improper installation or repair or improper storage;
- (b) Products whose mechanical serial number or electronic serial number has been removed, altered, or defaced;
- (c) Damage from exposure to moisture, humidity, excessive temperature or extreme environment conditions;
- (d) Damage resulting from connection to, or use of any accessory or other product

not approved or authorized by the company;

(e) Defects in appearance, cosmetic, decorative or structural items such as framing and non-operative parts;

(f) Product damaged from external causes such as fire, flooding, dirt, sand, weather conditions, battery leakage, blown fuse, theft or improper usage of any electrical source.

The Company disclaims liability for removal or reinstallation of the product, for geographic coverage, for inadequate signal reception by the antenna or for communications range or operation of the cellular system as a whole.

When sending your wireless device to Franklin Wireless' authorized distributions for repair or service, please note that any personal data or software stored on the device may be inadvertently erased or altered. Therefore, we strongly recommend you make a back up copy of all data and software contained on your device before submitting it for repair or service. This includes all contact lists, downloads (i.e. third-party software applications, games and graphics) and any other data added to your device. Franklin Wireless is not responsible for and does not guarantee restoration of any third-party software, personal information or memory data contained in, stored on, or integrated with any wireless device, whether under warranty or not, returned to Franklin Wireless' authorized distributors for repair or service. To obtain repairs or replacement within the terms of this Warranty, the product should be delivered with proof of Warranty coverage (e.g. dated bill of sale), the consumer's return address, daytime phone number and/or fax number and complete description of the problem, transportation prepaid, to the Company at the

address shown below or to the place of purchase for repair or replacement processing. In addition, for reference to an authorized Warranty station in your area, please call (800)959-3558 in the United States.

The extent of the company's liability under this warranty is limited to the repair or replacement provided above and, in no event, shall the company's liability exceed the purchase price paid by purchaser for the product.

Any implied warranties, including any implied warranty of merchant ability or fitness for a particular purpose, shall be limited to the duration of this written warranty. Any action for breach of any warranty must be brought within a period of 18 months from date of original purchase, but in no case shall the company be liable for a special consequential or incidental damages for breach of this or any other warranty, express or implied, whatsoever. The company shall not be liable for the delay in pending service under this warranty or loss of use during the time the produce is being repaired or replaced.

No person or representative is authorized to assume for the Company any liability other than expressed herein in connection with the sale of this product.

Some states or provinces do not allow limitations on how long an implied warranty lasts on the exclusion or limitation of incidental or consequential damage so the above limitation or exclusions may not apply to you. This Warranty gives you specific legal rights, and you may also have other rights, which vary from state to state or province to province.

Franklin's Authorized Service Center Address:

**5440 Morehouse Dr. STE 1000
San Diego, CA 92121**

4.5 Trademarks

Franklin and the logo are trademarks of Franklin.

Franklin Wireless, R526, and the Franklin Wireless logo are trademarks of Franklin Wireless.

Windows is a registered trademark of Microsoft Corporation.

4.6 Copyright

©2010 Franklin. Franklin and the logo are trademarks of Franklin.

Other marks are the property of their respective owners.